

# HEAT-TRACE PANELS

This section will help you design and select a dedicated heat-tracing power distribution panel. For design assistance, please contact your nVent representative or phone nVent at (800) 545-6258. Also, visit our web site at nVent.com.

## CONTENTS

<b>INTRODUCTION</b> .....	<b>1</b>
<b>SYSTEM OVERVIEW</b> .....	<b>2</b>
Heat-Trace Panels – Group Control .....	2
Heat-Trace Panels – Individual Control.....	4
<b>APPROVALS AND CERTIFICATIONS</b> .....	<b>5</b>
<b>DRAWINGS</b> .....	<b>5</b>
<b>PANEL DESIGN FOR THREE-PHASE SYSTEMS</b> .....	<b>5</b>
Overview.....	5
Panel Design .....	5
<b>PRODUCT SELECTION</b> .....	<b>9</b>
HTPG Overview .....	9
HTPG Catalog Number .....	9
HTPG Selection Process .....	10
HTPI Overview .....	11
HTPI Catalog Number.....	11
HTPI Selection Process.....	13

## INTRODUCTION

HTPG and HTPI panels are a cost-effective and convenient means of providing ground-fault protection to heat-tracing circuits.

nVent offers two types of heat-trace panels: the nVent RAYCHEM brand HTPG (Heat-Tracing Panel Group Control) and HTPI (Heat-Tracing Panel Individual Control). These distribution panels have the option of using ground-fault circuit breakers (30-mA trip level). Per national electrical codes and nVent requirements, ground-fault protection must be provided for each heat-tracing circuit. The HTPG and HTPI panels are a cost-effective and convenient means to provide this protection. nVent also supplies specialty panels for specific project requirements. Contact your nVent representative for additional information.

Fig. 1 represents a typical heat-tracing power distribution system. At the Motor Control Center (MCC) the voltage is reduced to the level required for the heat tracing. The transformer supplies this reduced voltage to the distribution panelboard, which contains the main circuit breaker and branch circuit breakers. From the branch circuit breakers (CB), the voltage is transferred to the heater's power connection box via wire/conduit or cable. This section will assist you in sizing and specifying the transformer and heat-tracing panel.

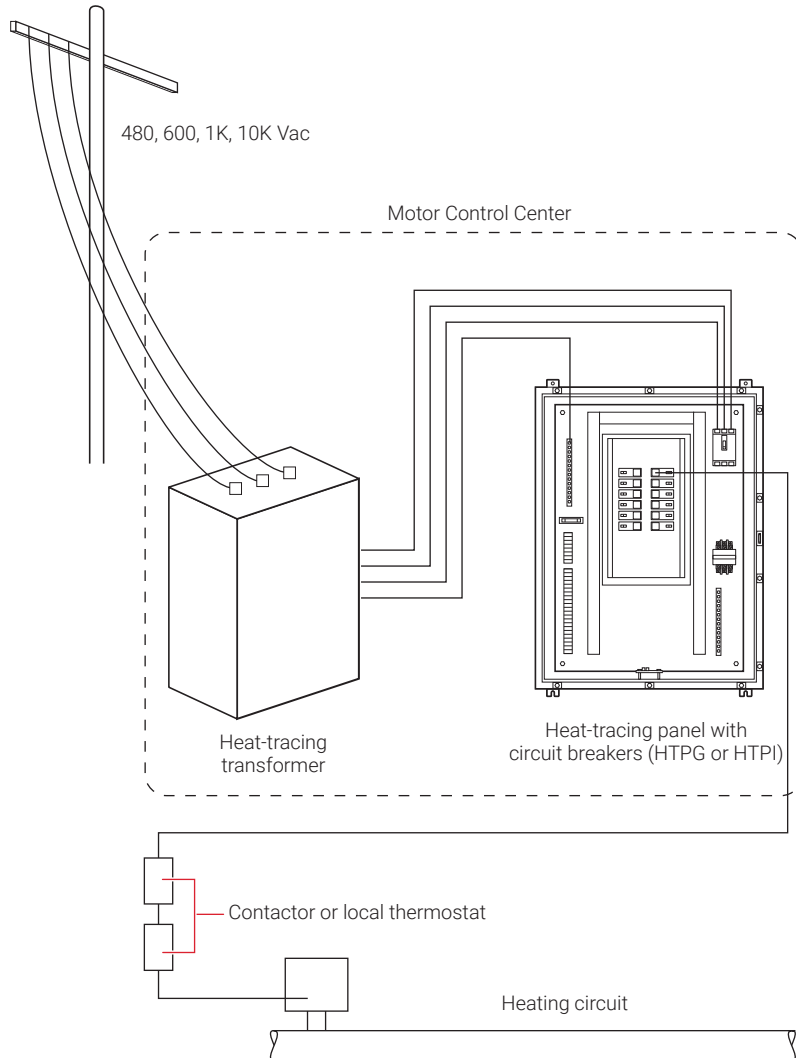

**Fig.1 Typical heat-tracing power distribution system**

**Heat-Trace Panels – Group Control**

**RAYCHEM HTPG**

The HTPG is a dedicated power distribution, control, ground-fault protection, monitoring, and alarm panel. This system is used for freeze protection control, broadband maintenance temperature control, or applications in which multiple circuits (branch circuit breakers) are energized at one time.

A typical HTPG panel includes a wall-mounted enclosure, assembled panelboard, main contactor, main circuit breaker, Hand/Off/Auto switch, contactor-energize light, and door disconnect handle.

Fig. 2 shows a typical HTPG panel layout. This wall-mounted enclosure contains an assembled panelboard, main contactor, main circuit breaker, Hand/Off/Auto switch, and contactor-energize light. The panel has options for terminal blocks, alarm relay (form C contacts), common alarm light, door disconnect handle, and alarm horn.

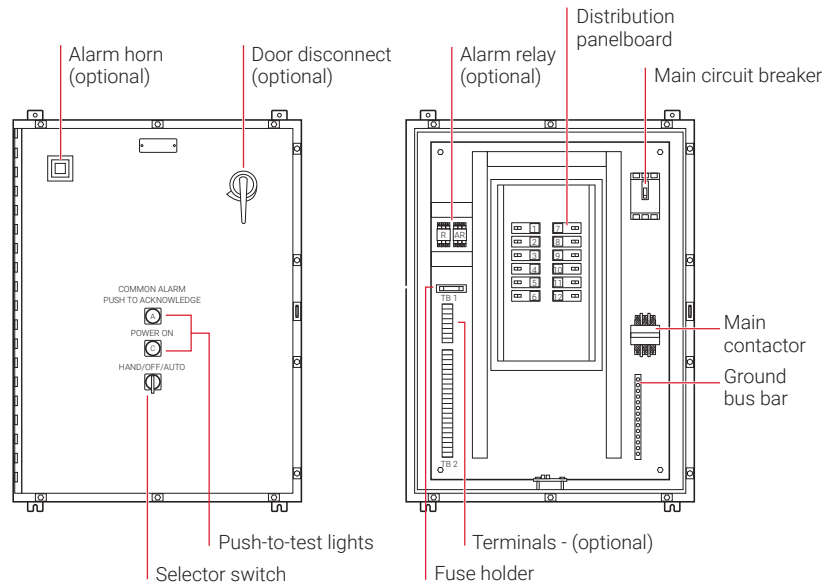

**Fig. 2 Typical HTPG panel layout**

Fig. 3 depicts a typical HTPG schematic. The device that energizes the main contactor can be an ambient sensing thermostat (mounted remotely), an electronic controller, a snow sensor controller, or any device with a contact that changes state when the heat tracing is energized.

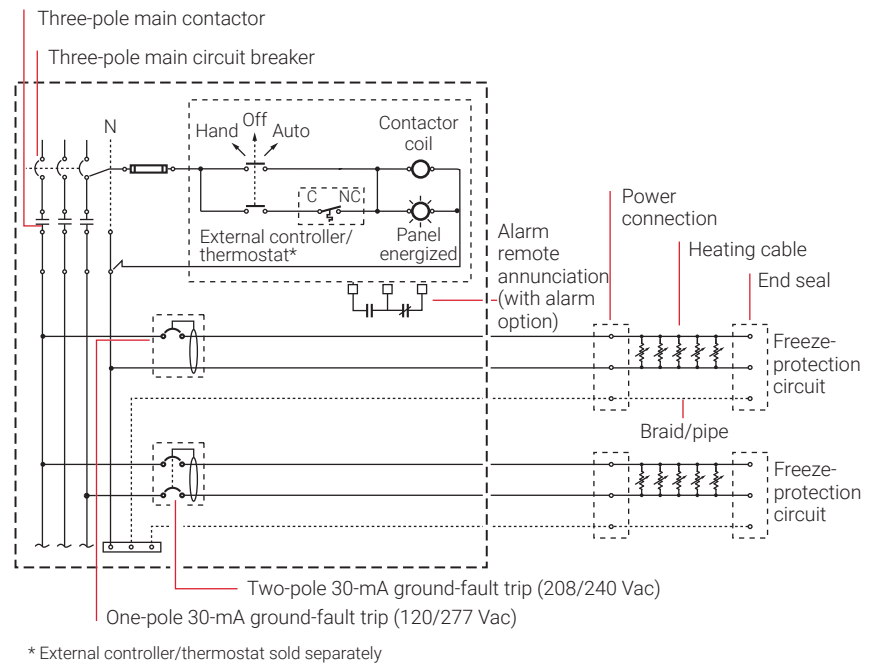

**Fig. 3 Typical HTPG schematic**

## Heat-Trace Panels – Individual Control

### RAYCHEM HTPI

A typical HTPI panel includes a wall-mounted enclosure, assembled panelboard, main circuit breaker, and door disconnect handle.

The HTPI is a dedicated power distribution, ground-fault protection, monitoring, and alarm panel. This system is used with a line sensing thermostat (mounted remotely) or a line sensing electronic controller to give individual line sensing control.

Fig. 4 shows a typical panel layout of an HTPI. This wall-mounted enclosure contains an assembled panelboard and main circuit breaker. The panel has options for terminal blocks, alarm relay (form C contacts), common alarm light, door disconnect handle, and alarm horn. Fig. 5 depicts a typical HTPI schematic.

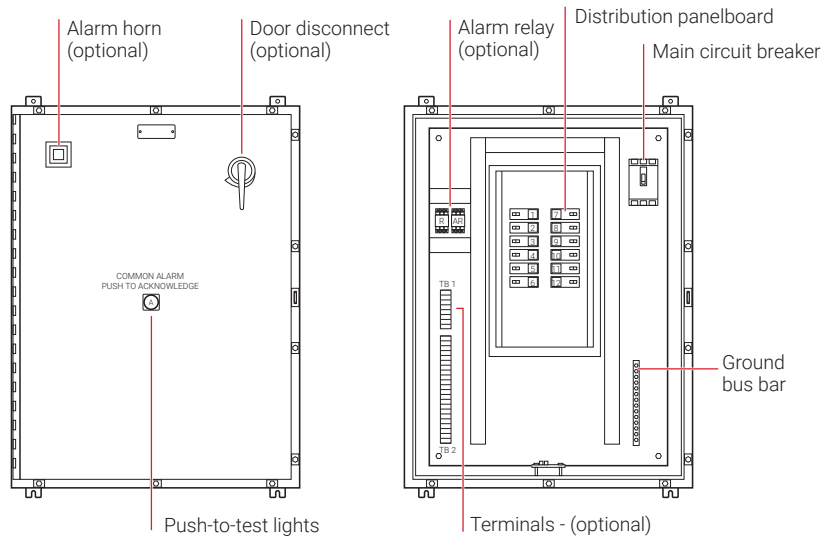

**Fig. 4 Typical HTPI panel layout**

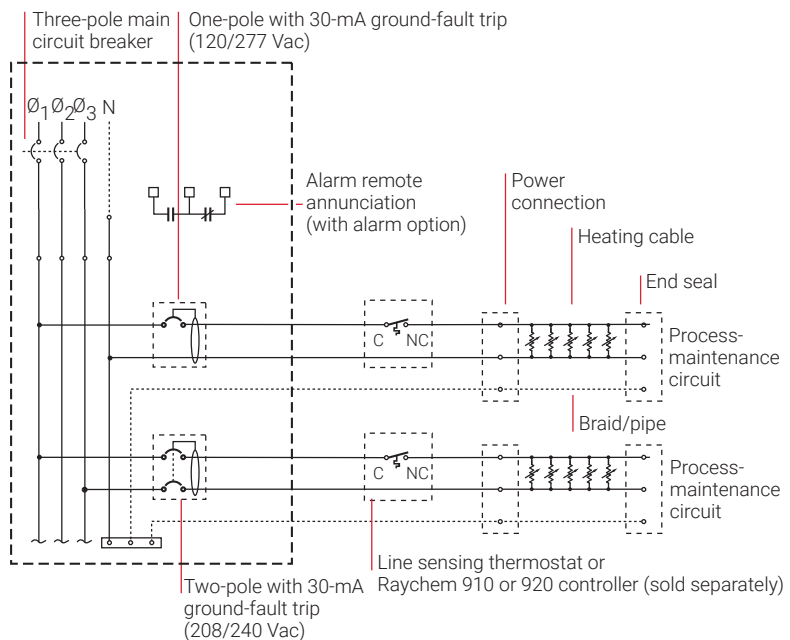

**Fig. 5 Typical HTPI schematic**

**APPROVALS AND CERTIFICATIONS**

The HTPG and HTPI heat-trace panels are built to UL 508A guidelines and labeled accordingly. The UL508 control panel label is a certification that all assembly, wiring, and testing was done in strict accordance with UL guidelines. Control panel manufacturers must complete an extensive review process of their procedures and demonstrate an understanding of electrical systems, code requirements, and various safety issues in order to qualify as an ETL Listed panel shop. They are subsequently reviewed on a quarterly basis to ensure that all finished products utilize UL-marked components and are manufactured to all UL standards. Assembly and testing of all panels is done in a ETL Certified facility. All panels are functionally tested before shipment. Other applicable standards include UL 67 for panelboards, UL 50 for cabinets, National Electrical Code, NEMA Standards PB1, and Federal Inspection W-P-115C.



**DRAWINGS**

For each panel configuration, a set of drawings (elevation/BOM and schematic) is created. These drawings are sent to the purchaser for approval or for information only (panel released at time of order). The drawings are 11" x 17" (B size).

**PANEL DESIGN FOR THREE-PHASE SYSTEMS**

**Overview**

The panel design process involves four steps:

- 1** Gather the necessary information.
  - Total start-up circuit breaker (CB) amps
  - KVA rating of the transformer
  - Phase-to-neutral voltage of the transformer secondary ( $V_{p-n}$ )
  - Phase-to-phase voltage of the transformer secondary ( $V_{p-p}$ )
- 2** Determine main circuit breaker and transformer size.
- 3** Select the panelboard.
- 4** Select the ground-fault circuit breaker.

**Panel Design**

Panel Design
1. Gather information
2. Determine main circuit breaker and transformer size
3. Select panelboard
4. Select ground-fault circuit breaker

**Step 1 Gather the necessary information**

To begin your panel design, gather and record the following information:

- Total start-up CB Amps.....
- KVA rating of the transformer .....
- Phase-to-neutral voltage of the transformer secondary ( $V_{p-n}$ ) .....
- Phase-to-phase voltage of the transformer secondary ( $V_{p-p}$ ).....

**Note:** Start-up Amps may be obtained by using TraceCalc Pro design software or by contacting your nVent representative.

Panel Design
1. Gather information
2. Determine main circuit breaker and transformer size
3. Select panelboard
4. Select ground-fault circuit breaker

## Step 2 Determine main circuit breaker and transformer size

### Main Breaker Sizing

The purpose of the main circuit breaker is to protect the panelboard bussing, the transformer, and the wiring between the transformer and the panelboard. The main breaker also provides a way to disconnect power to the panelboard for maintenance purposes. Table 1 on page <?>, shows the maximum size main circuit breaker that can be used with each size transformer. Choose the appropriate main circuit breaker based upon your application.

### Transformer Sizing

Transformers must be sized for the start-up load. This ensures that the main breaker, which protects the transformer, is large enough to take the start-up currents produced by heaters that have transient currents, such as self-regulating heaters. For most applications, this is based on the total start-up current. The formula for calculating minimum transformer rating is:

$$\frac{V_{p-n} \times I_T \times SF}{1000} = \text{KVA} \quad \text{or} \quad \frac{V_{p-p} \times I_T \times SF \times 1.73}{1000} = \text{KVA}$$

Where:	KVA	=	KVA rating of the transformer
	SF	=	Safety factor (allowance for spare capacity)
	$I_T$	=	Total start-up current
	$V_{p-n}$	=	Phase-to-neutral voltage of the transformer secondary
	$V_{p-p}$	=	Phase-to-phase voltage of the transformer secondary

After you have applied the above formula, go to Table 1 and choose the next largest standard transformer.

**Note:** The above formulas are based upon the assumption that the transformer is perfectly balanced and the entire panelboard will be energized at the same minimum ambient temperature for which the branch circuit breakers were sized.

**Note regarding transformer primary protection:** In most cases, the customer will provide the primary main circuit breaker. However, if you must provide the main circuit breaker on the primary side, the formula is:

$$\frac{\text{KVA} \times 1000 \times 1.25 \times 1.73}{V_{p-p}} = \text{Next largest standard breaker}$$

Where:	KVA	=	KVA rating of the transformer
	1.25	=	NEC factor
	$V_{p-p}$	=	Phase-to-phase voltage supplying transformer

**TABLE1 MAXIMUM THREE-PHASE MAIN CIRCUIT BREAKER SIZING**

Trans. size (KVA)	Maximum primary main circuit breaker size				Maximum secondary main circuit breaker size			
	600 V		480 V		120/208 V		277 V	
	Calculated CB size	4-F	Calculated CB size	6-F	Calculated CB size	15	Calculated CB size	6-F
3	3.6	4-F	4.5	6-F	10.4	15	4.5	6-F
6	7.2	9-F	9.0	15	20.8	30	9.0	15
9	10.8	15	13.5	15	31.3	40	13.5	15
15	18.0	20	22.6	30	52.1	60	22.6	30
30	36.1	40	45.1	50	104.2	125	45.1	50
45	54.1	60	67.7	70	156.3	175	67.7	70
75	90.2	100	112.8	125	260.4	300	112.8	125
112.5	135.3	150	169.1	175	390.6	400	169.2	175
150	180.4	200	225.5	225	520.8	600	225.6	225
225	270.6	300	338.3	400	781.3	800	338.4	400
300	360.8	400	451.1	500	1041.7	1200	451.3	500

**TABLE 2 MAXIMUM SINGLE-PHASE MAIN CIRCUIT BREAKER SIZING**

Trans. size (KVA)	Maximum primary main circuit breaker size				Maximum primary main circuit breaker size	
	600 V		480 V		120/240 V	
	Calculated CB size	9-F	Calculated CB size	9-F	Calculated CB size	20
3	6.3	9-F	7.8	9-F	15.6	20
5	10.4	15	13.0	15	26.0	30
7.5	15.6	20	19.5	20	39.1	40
10	20.8	30	26.0	30	52.1	60
15	31.3	40	39.1	40	78.1	80
25	52.1	60	65.1	70	130.2	150
37.5	78.1	80	97.7	100	195.3	200
50	104.2	125	130.2	150	260.4	300
75	156.3	175	195.3	200	390.6	400

Panel Design
1. Gather information
2. Determine main circuit breaker and transformer size
3. Select panelboard
4. Select ground-fault circuit breaker

**Step 3 Select the panelboard**

The standard bus ratings (amperage/phase) for panelboards are 100 A, 225 A, and 400 A. The higher the bus rating, the more expensive the panelboard. Where possible, it is most cost-effective to limit the main circuit breaker and bus rating to 225 A. As mentioned, the main circuit breaker must protect the bussing in the panelboard. Therefore, your main circuit breaker will determine your panelboard bus rating. The maximum number of branch spaces available in panelboards are: 18, 30, 42 and 54 spaces.

**Note:** Per the NEC, a single panelboard can accommodate a maximum of 42 connections. There are some ground-fault circuit breaker (GFCB) options in which the number of panelboard connections is less than the number of spaces provided. These are discussed in the next section.

Panel Design
1. Gather information
2. Determine main circuit breaker and transformer size
3. Select panelboard
4. Select ground-fault circuit breaker

## Step 4 Select ground-fault circuit breaker

The number of spaces taken by GFCBs is a function of both the voltage and whether the GFCBs have alarms. Table 3 lists the number of spaces each breaker takes in a panelboard, as well as the number of connections to a panelboard.

**TABLE 3 GFCB PANELBOARD REQUIREMENT**

Voltage	Number of spaces per GFCB		
	Without alarm	With alarm relay	With bell alarm
120	1	1	2
208/240	2	2	3
277	2	2	2

### Alarm Options

#### Bell alarm versus relay alarm

We offer two types of alarm options for the HTPI and HTPG heat-trace panels: bell and relay.

The bell alarm option uses a ground-fault circuit breaker with an alarm contact built into the breaker. Upon a ground fault or trip condition, this alarm contact changes state (closes), sending a signal to the common alarm relay provided in the panel that a breaker has tripped. Once in alarm, turning the breaker to the "Off" or "On" position clears the alarm. Due to the alarm contact, the breakers are larger and take an extra space in the panelboard for 120 / 208 / 240 V breakers, thereby reducing the number of breakers you can install in a given panelboard (see Fig. 6).

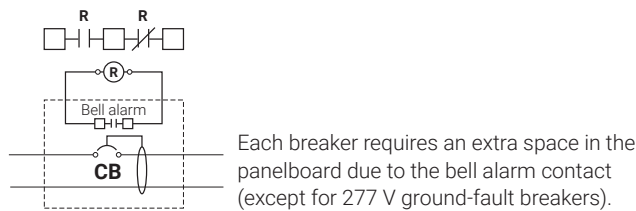

**Fig. 6 Ground-fault circuit breaker with bell alarm contact**

The relay alarm uses standard ground-fault circuit breakers wired to a relay. Upon a ground fault / trip condition or if / when the breaker is turned off, the relay changes state (closes) sending a signal to the common alarm relay provided in the panel that the breaker has tripped or has been turned to the "Off" position. Once in alarm, turning the breaker to the "On" position or removing the relay will clear the alarm (see Fig. 7).

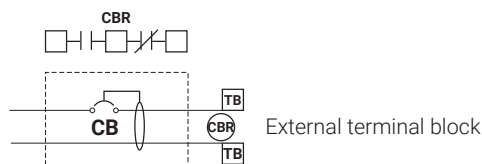

**Fig. 7 Ground-fault circuit breaker with external relay for alarmBuried piping**



**HTPG Overview**

The HTPG selection process involves two steps:

- 1** Gather the necessary information:
  - Voltage
  - Panelboard size
  - Circuit breaker type and rating
  - Number of circuit breakers (availability per voltage)
  - Type of enclosure
  - Main circuit breaker and contactor
  - Options
- 1** Assemble the catalog number.

**HTPG Catalog Number**

HTPG comes in a variety of configurations. The following chart outlines the elements that constitute a configuration and the corresponding catalog number.

**HTPG - Voltage - Panelboard - C.B. type - # of C.B./# of poles (rating) - Enclosure - MCB - Options**

**HTPG - 277/480 - 30 - 2 - 14/1P (30) - 4X - 200 - H**

<p><b>Voltage</b></p> <table border="0" style="width: 100%;"> <tr> <td style="width: 33%;">120/208</td> <td style="width: 33%;">120/240*</td> <td style="width: 33%;">277/480</td> </tr> </table> <p><b>Panelboard size</b></p> <p>18 = 18 space panelboard (277 V only)          30 = 30 space panelboard          42 = 42 space panelboard          54 = 54 space panelboard (277 V only)</p> <p><b>Circuit breaker type</b></p> <p>2 = GFCB (30-mA trip) without alarm          3 = GFCB (30-mA trip) with bell alarm          4 = GFCB (30-mA trip) with relay alarm (includes terminal block option). Not available for 277 V</p> <p><b>Number of circuit breakers/number of poles (circuit breaker rating) see prior page</b></p> <p># of breakers (no bell alarm option)</p> <table border="0" style="width: 100%;"> <tr> <td></td> <td style="text-align: center;"><b>120 V</b></td> <td style="text-align: center;"><b>208 V</b></td> <td style="text-align: center;"><b>240 V</b></td> <td style="text-align: center;"><b>277V</b></td> </tr> <tr> <td></td> <td style="text-align: center;"><b>(1P)</b></td> <td style="text-align: center;"><b>(2P)</b></td> <td style="text-align: center;"><b>(2P)</b></td> <td style="text-align: center;"><b>(1P)</b></td> </tr> <tr> <td>18</td> <td style="text-align: center;">(1-18)</td> <td style="text-align: center;">(1-8)</td> <td style="text-align: center;">(1-8)</td> <td style="text-align: center;">(1-8)</td> </tr> <tr> <td>30</td> <td style="text-align: center;">(1-30)</td> <td style="text-align: center;">(1-14)</td> <td style="text-align: center;">(1-14)</td> <td style="text-align: center;">(1-14)</td> </tr> <tr> <td>42</td> <td style="text-align: center;">(1-42)</td> <td style="text-align: center;">(1-20)</td> <td style="text-align: center;">(1-20)</td> <td style="text-align: center;">(1-20)</td> </tr> <tr> <td>54</td> <td style="text-align: center;">-</td> <td style="text-align: center;">-</td> <td style="text-align: center;">-</td> <td style="text-align: center;">(1-26)</td> </tr> </table> <p># of breakers (bell alarm option)</p> <table border="0" style="width: 100%;"> <tr> <td></td> <td style="text-align: center;"><b>120 V</b></td> <td style="text-align: center;"><b>208 V</b></td> <td style="text-align: center;"><b>240 V</b></td> <td style="text-align: center;"><b>277 V</b></td> </tr> <tr> <td></td> <td style="text-align: center;"><b>(1P)</b></td> <td style="text-align: center;"><b>(2P)</b></td> <td style="text-align: center;"><b>(2P)</b></td> <td style="text-align: center;"><b>(1P)</b></td> </tr> <tr> <td>18</td> <td style="text-align: center;">(1-8)</td> <td style="text-align: center;">(1-6)</td> <td style="text-align: center;">(1-6)</td> <td style="text-align: center;">(1-8)</td> </tr> <tr> <td>30</td> <td style="text-align: center;">(1-14)</td> <td style="text-align: center;">(1-10)</td> <td style="text-align: center;">(1-10)</td> <td style="text-align: center;">(1-14)</td> </tr> <tr> <td>42</td> <td style="text-align: center;">(1-20)</td> <td style="text-align: center;">(1-14)</td> <td style="text-align: center;">(1-14)</td> <td style="text-align: center;">(1-20)</td> </tr> <tr> <td>54</td> <td style="text-align: center;">-</td> <td style="text-align: center;">-</td> <td style="text-align: center;">-</td> <td style="text-align: center;">(1-26)</td> </tr> </table>	120/208	120/240*	277/480		<b>120 V</b>	<b>208 V</b>	<b>240 V</b>	<b>277V</b>		<b>(1P)</b>	<b>(2P)</b>	<b>(2P)</b>	<b>(1P)</b>	18	(1-18)	(1-8)	(1-8)	(1-8)	30	(1-30)	(1-14)	(1-14)	(1-14)	42	(1-42)	(1-20)	(1-20)	(1-20)	54	-	-	-	(1-26)		<b>120 V</b>	<b>208 V</b>	<b>240 V</b>	<b>277 V</b>		<b>(1P)</b>	<b>(2P)</b>	<b>(2P)</b>	<b>(1P)</b>	18	(1-8)	(1-6)	(1-6)	(1-8)	30	(1-14)	(1-10)	(1-10)	(1-14)	42	(1-20)	(1-14)	(1-14)	(1-20)	54	-	-	-	(1-26)	<p><b>Option</b></p> <p>0 = None          A = Alarm horn (requires C.B. type 3 or 4)          B = Alarm beacon (requires C.B. type 3 or 4)          C = Heat-trace contactor failure light          D = Door disconnect          E = Environmental purge (NEMA Type 4 or 4X enclosures only)          G = Panel power-on light          H = Space heater and thermostat          L = Individual circuit breaker trip indication lights (requires C.B. type 4)          P = Heat-trace energized light          T = Terminal blocks (prewired)          W = Wired for ETI controller          Z = Z-purge system (NEMA Type 4 or 4X enclosures only)  <b>SP = Special requirement: Must contain complete description of variance</b></p> <p><b>MCB</b></p> <p><b>Main circuit breaker and contactor</b></p> <table border="0" style="width: 100%;"> <tr> <td style="text-align: left;"><b>Panelboard size</b></td> <td style="text-align: center;"><b>120/208</b></td> <td style="text-align: center;"><b>120/240</b></td> <td style="text-align: center;"><b>277/480</b></td> </tr> <tr> <td>18</td> <td style="text-align: center;">50, 100</td> <td style="text-align: center;">50, 100</td> <td style="text-align: center;">30, 50, 70, 125</td> </tr> <tr> <td>30</td> <td style="text-align: center;">50, 100, 150, 200, 225</td> <td style="text-align: center;">50, 60, 80, 150, 175, 200, 225</td> <td style="text-align: center;">50, 70, 125, 175, 225</td> </tr> <tr> <td>42</td> <td style="text-align: center;">50, 100, 150, 200, 225</td> <td style="text-align: center;">50, 60, 80, 150, 175, 200, 225</td> <td style="text-align: center;">50, 70, 125, 175, 225</td> </tr> <tr> <td>54</td> <td style="text-align: center;">-</td> <td style="text-align: center;">-</td> <td style="text-align: center;">50, 70, 125, 175, 225</td> </tr> </table> <p><b>Enclosure</b></p> <p>12= NEMA Type 12 (indoors)          4 = NEMA Type 4 (outdoors)          4X= NEMA Type 4X (stainless steel-outdoors)</p>	<b>Panelboard size</b>	<b>120/208</b>	<b>120/240</b>	<b>277/480</b>	18	50, 100	50, 100	30, 50, 70, 125	30	50, 100, 150, 200, 225	50, 60, 80, 150, 175, 200, 225	50, 70, 125, 175, 225	42	50, 100, 150, 200, 225	50, 60, 80, 150, 175, 200, 225	50, 70, 125, 175, 225	54	-	-	50, 70, 125, 175, 225	
120/208	120/240*	277/480																																																																																			
	<b>120 V</b>	<b>208 V</b>	<b>240 V</b>	<b>277V</b>																																																																																	
	<b>(1P)</b>	<b>(2P)</b>	<b>(2P)</b>	<b>(1P)</b>																																																																																	
18	(1-18)	(1-8)	(1-8)	(1-8)																																																																																	
30	(1-30)	(1-14)	(1-14)	(1-14)																																																																																	
42	(1-42)	(1-20)	(1-20)	(1-20)																																																																																	
54	-	-	-	(1-26)																																																																																	
	<b>120 V</b>	<b>208 V</b>	<b>240 V</b>	<b>277 V</b>																																																																																	
	<b>(1P)</b>	<b>(2P)</b>	<b>(2P)</b>	<b>(1P)</b>																																																																																	
18	(1-8)	(1-6)	(1-6)	(1-8)																																																																																	
30	(1-14)	(1-10)	(1-10)	(1-14)																																																																																	
42	(1-20)	(1-14)	(1-14)	(1-20)																																																																																	
54	-	-	-	(1-26)																																																																																	
<b>Panelboard size</b>	<b>120/208</b>	<b>120/240</b>	<b>277/480</b>																																																																																		
18	50, 100	50, 100	30, 50, 70, 125																																																																																		
30	50, 100, 150, 200, 225	50, 60, 80, 150, 175, 200, 225	50, 70, 125, 175, 225																																																																																		
42	50, 100, 150, 200, 225	50, 60, 80, 150, 175, 200, 225	50, 70, 125, 175, 225																																																																																		
54	-	-	50, 70, 125, 175, 225																																																																																		

\* Single phase

**Fig. 8 HTPG catalog number elements**

### Voltage

This is the voltage at which the heater is powered. If you have a combination of 120 V and 208 V heaters in the same panelboard, use 120 / 208 as the voltage. For 240 V, we are assuming that the voltage to the panelboard is single-phase (two phases and a neutral).

### Panelboard size

Specify the panelboard size you will require based on the number and type of circuit breakers required. You can specify a larger-than-required panelboard for spare space.

### Circuit breaker type and rating

Specify the type of ground-fault breakers you require in the panelboard. In the parenthesis, fill in the amperage of the breakers (refer to Fig. 8). If more than one amperage is required, then list all the amperages; for example, 3/2P(50), 4/2P(40).

### number of breakers

Fig. 8 lists the standard numbers of breakers we offer in a single panelboard. If you require more or fewer than the number of breakers shown, list the actual number of breakers required and we can provide a factory quote.

### Enclosure

Fig. 8 shows the standard enclosures. If the panel will be located in a hazardous location (CID1 or CID2), specify 7 for a NEMA Type 7 explosion-proof enclosure; specify NEMA Type 4 or 4X enclosure for a Z-purge system and choose Z (Z purged) option.

### MCB / contactor

If you require a main circuit breaker less than 100 A, state the required amperage. If you require a main circuit breaker larger than 225 A, state the required amperage and we can provide a factory quote.

## HTPG Selection Process

HTPG Selection
1. Gather information
2. Assemble catalog number

### Step 1 Gather the necessary information

Gather and record the following information:

- Voltage.....
- Panelboard size .....
- Circuit breaker type and rating .....
- Number of circuit breakers (availability per voltage).....
- Type of enclosure .....
- MCB/contactor .....
- Options .....

### Example: Information on sample application

Voltage	277
Panelboard size	30
Circuit breaker type and rating	30 A without alarm
Number of breakers	14
Type of enclosure	NEMA Type 4X
MCB/contactor	200 A MCB/contactors
Options	Space heater with thermostat

HTPG Selection
1. Gather information
2. Assemble catalog number

## Step 2 Assemble the catalog number

Example: HTPG-277/480-30-2-14/1P(30)-4X-200-H

### HTPI Overview

The HTPI selection process involves two steps:

#### 1 Gather the necessary information:

- Voltage
- Panelboard size
- Circuit breaker type and rating
- Number of circuit breakers (availability per voltage)
- Type of enclosure
- MCB
- Options

#### 2 Determine configuration and the corresponding catalog number.

### HTPI Catalog Number

HTPI comes in a variety of configurations. The following chart outlines the elements that constitute a configuration and the corresponding catalog number.

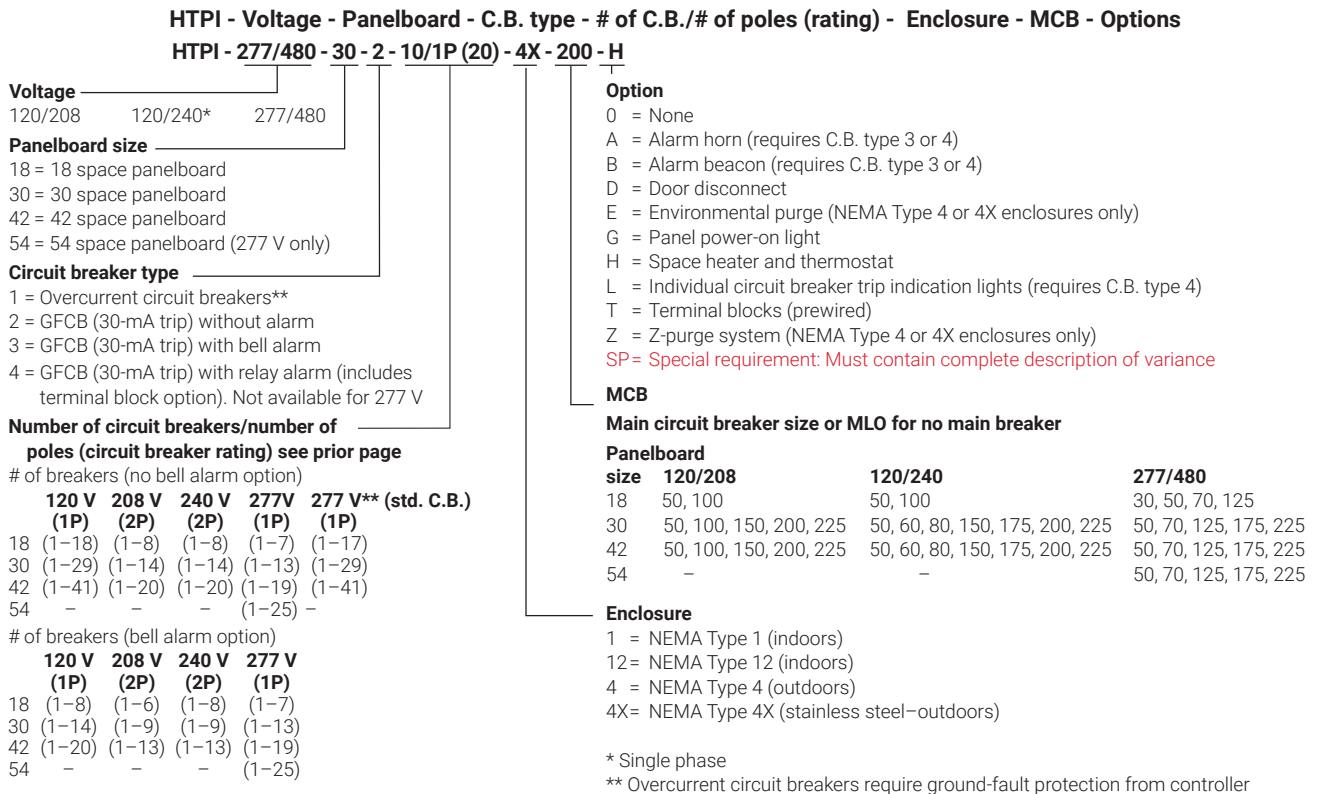

Fig. 9 HTPI catalog number elements

## **Voltage**

This is the voltage at which the heater is powered. If you have a combination of 120 V and 208 V heaters in the same panelboard, use 120 / 208 as the voltage. For 240 V, we are assuming that the voltage to the panelboard is single-phase (two phases and a neutral).

## **Panelboard size**

Specify the panelboard size you will require based on the number and type of circuit breakers required. You can specify a larger-than-required panelboard for spare space.

## **Circuit breaker type and rating**

Specify the type of breakers you require in the panelboard. If you choose a standard circuit breaker, the ground-fault protection function must come from the controller. In the parenthesis ( ), fill in the amperage of the breakers (refer to Fig. 9). If more than one amperage is required, then list all the amperages; for example, 3/2P(50), 4/2P(40).

## **number of breakers**

Fig. 9 lists the standard numbers of breakers we offer in a single panelboard. If you require more or fewer than the number of breakers shown, list the actual number of breakers required and we can provide a factory quote.

## **Enclosure**

Fig. 9 shows the standard enclosures. If the panel will be located in a hazardous location (CID1 or CID2), specify 7 for a NEMA Type 7 explosion-proof enclosure; specify NEMA Type 4 or 4X enclosure for a Z-purge enclosure and choose Z (Z purged) option.

## **MCB**

If you require a main circuit breaker less than 100 A, state the required amperage. If you require a main circuit breaker larger than 225 A, state the required amperage and we can provide a factory quote.

**HTPI Selection Process**

HTPI Selection
1. Gather information
2. Assemble catalog number

**Step 1 Gather the necessary information**

Gather and record the following information:

- Voltage.....
- Panelboard size .....
- Circuit breaker type and rating .....
- Number of circuit breakers (availability per voltage).....
- Type of enclosure .....
- Type of main circuit breaker.....
- Options .....

**Example: Information on sample application**

Voltage	277
Panelboard size	30
Circuit breaker type and rating	20 A without alarm
Number of breakers	10
Type of enclosure	NEMA Type 4X
Type of main circuit breaker	200 A main circuit breaker
Options	Space heater with thermostat

HTPI Selection
1. Gather information
2. Assemble catalog number

**Step 2 Assemble the catalog number**

**Example: HTPI-277/480-30-2-10/1P(20)-4X-200-H**

#### **North America**

Tel +1.800.545.6258  
Fax +1.800.527.5703  
thermal.info@nvent.com

#### **Europe, Middle East, Africa**

Tel +32.16.213.511  
Fax +32.16.213.604  
thermal.info@nvent.com

#### **Asia Pacific**

Tel +86.21.2412.1688  
Fax +86.21.5426.3167  
cn.thermal.info@nvent.com

#### **Latin America**

Tel +1.713.868.4800  
Fax +1.713.868.2333  
thermal.info@nvent.com



[nVent.com](https://www.nvent.com)

Our powerful portfolio of brands:

**CADDY ERICO HOFFMAN RAYCHEM SCHROFF TRACER**