

HEAT-SHRINK CONNECTION OR SPLICE KIT FOR PI HEATING CABLES

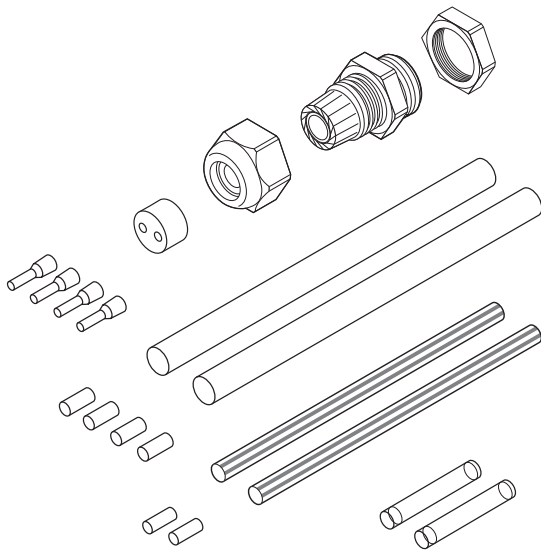

The nVent RAYCHEM CS20-2.5-PI-NH kit is designed for terminating polymer insulated (PI) series resistance heating cables.

The CS20-2.5-PI-NH may be used in non-hazardous areas only. The kit contains components required for the installation of either: a connection of (2) cold leads- to a heating cable or for (2) splices between two heating cables. The splice kit employs easy to use heat shrinkable tubing that after installation forms a semi-flexible moisture proof encapsulation. Electrical continuation is maintained via crimps for both conductor and braid. Thanks to its low profile design the finished connection can be easily installed under the insulation directly on the pipe. The kit is designed for use with junction boxes with M20 entries.

Each CS20-2.5-PI-NH kit contains 2 connection sets. The crimps must be installed using an appropriate crimp tool (CW-CT-KIT or equivalent).

APPLICATION

Heat shrink based connection/splice kit for single core polymer series resistance heating cable. Only use with PTFE sheathed cables (XPI and XPI-S).

KIT CONTENTS

- 4 x Heat shrinkable tubes (PTFE/FEP)
- 2 x green/yellow tube for the braid.
- 6 x Crimp connectors (crimp for conductor and braid)
- 1 x polyamide gland with dual hole sealing grommet M20 threaded, suitable for cables ranging from 4.8 to 7 mm diameter.
- 1 x Installation instruction

APPROVALS

Suitable for non hazardous area installation only.

EAC (Russia, Kazakhstan, Belarus)
For other countries contact your local nVent representative.

DIMENSIONS

Overall length ~130 mm, \varnothing ~10 mm

TECHNICAL DATA

Max. cold lead size	2,5 mm ²
Max. operating temperature	205°C
Min. installation temperature	-50°C
Max. operating voltage	750 Vac
Max. operating current	25 A

ORDERING DETAILS

Order reference	CS20-2.5-PI-NH
Part number (Weight)	1244-000585 (0.1 kg)

North America

Tel +1.800.545.6258
Fax +1.800.527.5703
thermal.info@nvent.com

Europe, Middle East, Africa

Tel +32.16.213.511
Fax +32.16.213.604
thermal.info@nvent.com

Asia Pacific

Tel +86.21.2412.1688
Fax +86.21.5426.3167
cn.thermal.info@nvent.com

Latin America

Tel +1.713.868.4800
Fax +1.713.868.2333
thermal.info@nvent.com



nVent.com

Our powerful portfolio of brands:

CADDY ERICO HOFFMAN RAYCHEM SCHROFF TRACER